

BROEN-LAB EMERGENCY SHOWER SYSTEMS



reddot design award
winner 2013



**EMERGENCY
SHOWER SYSTEMS**

BROEN-LAB

TABLE OF CONTENT

Table of Content / Product Overview	2	Frost Protected Emergency Showers & Eye Washes	
Introduction	3	Introduction	17
Emergency Showers & Eye Washes		Frost Protected Combination Showers	18
FALCON - A Cloud-Based Monitoring System	4	Frost Protected Body Showers	19
Hand-Held Eye Showers & Accessories	5-6	Frost Protected Eye/Face Showers	20
Eye/Face Showers	7	Heated Tank Showers	21
Recessed Emergency Showers	8-9	Mobile & Portable Emergency Showers	22
Body Showers	10	Accessories for Frost Protected Showers	24
Combination Showers	11	General Information	25
Emergency Showers in Stainless Steel (316L)	12	International Standards	26-27
Accessories for Emergency Showers	13-14	Technical Information	28
Connections for Emergency Showers	15	Notes	29-31
Test Equipment for Emergency Showers / Eye Wash Bottles	16		

PRODUCT OVERVIEW

- Please refer to the actual page for product versions

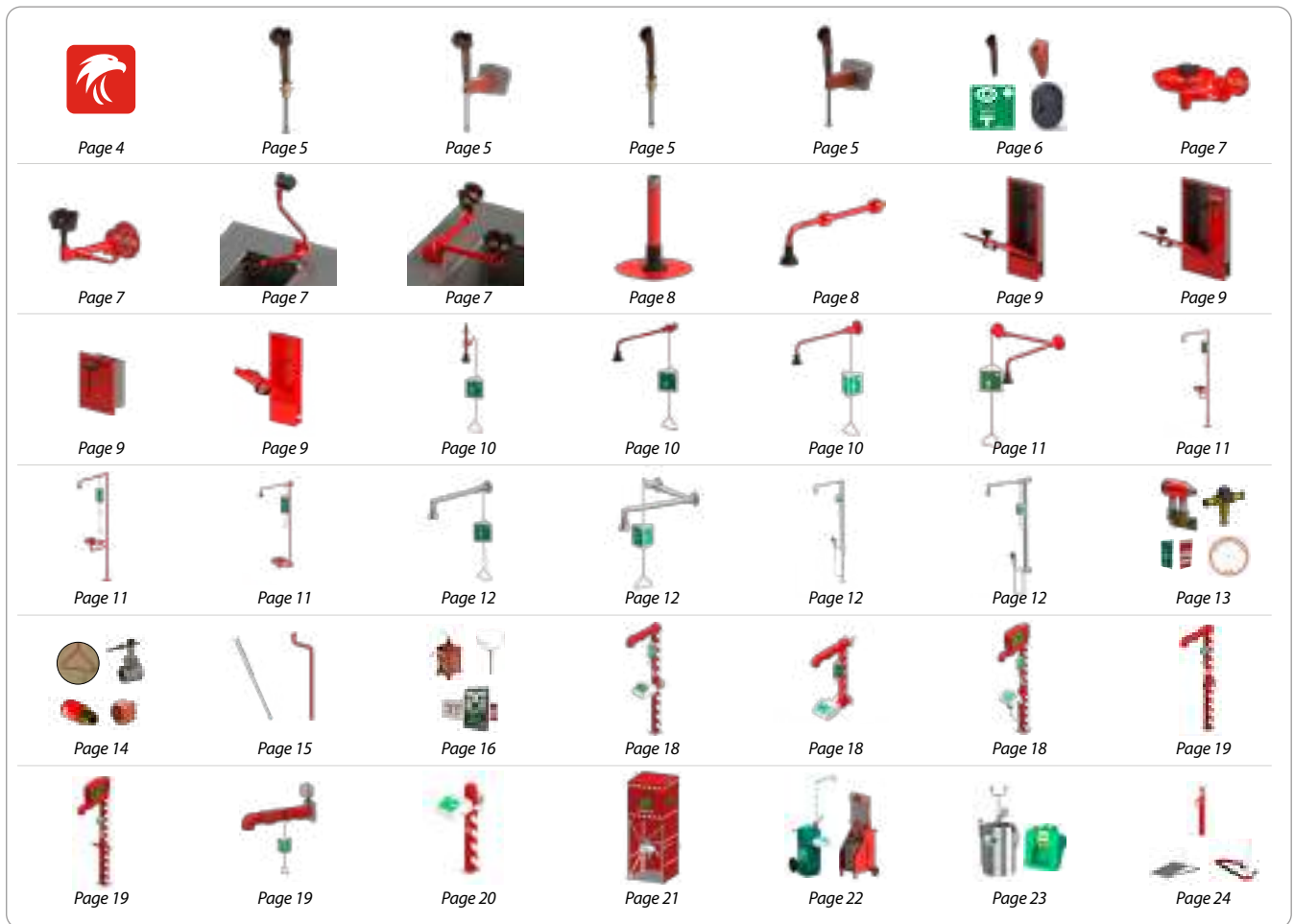



Our extensive knowledge allows us to continually develop and optimize our products so that they meet our customer needs and specifications. Safety, functionality and quality are an integral part of our product design and flexibility.

BROEN-LAB – A SAFE CHOICE

- Premium quality since 1948
- Complete product range
- Compliant with international standards
- Proven functionality world-wide
- Spare parts available for a guaranteed 10-year period

CERTAINTY

BROEN-LAB's Safety Wheel encapsulates our entire emergency shower system universe. The levels of protection, compliance, and certainty each represent a key aspect of what we offer at BROEN-LAB. Together, these levels help create the safest and most efficient setup, allowing you to maintain a high level of employee safety.

- » **Protection** - BROEN-LAB offers a complete range of emergency shower systems tailored to your business need and designed to treat body, face and eyes quickly and efficiently. The ability to react instantly is crucial, and with an emergency shower system from BROEN-LAB, you can be confident that you have the best protection.
- » **Compliance** - All BROEN-LAB solutions fully comply with international standards. However, service and maintenance are crucial to maintaining compliance with EN15154 and ANSI Z358.1. That's why we offer comprehensive servicing of your emergency showers, including scheduled visits throughout the year to test flow rate, spray pattern, and water quality, ensuring that all necessary documentation is up to date.
- » **Certainty** - Do you want assurance that your emergency shower solution is fully functional 24/7? If yes, then FALCON is the solution for you. FALCON is a cloud-based safety management system that tracks and collects real-time data from all your emergency showers. The system notifies selected employees if an emergency shower is activated or in case of any system errors. Additionally, it simplifies the maintenance process and ensures professional testing documentation.

Read more about FALCON on page 4.

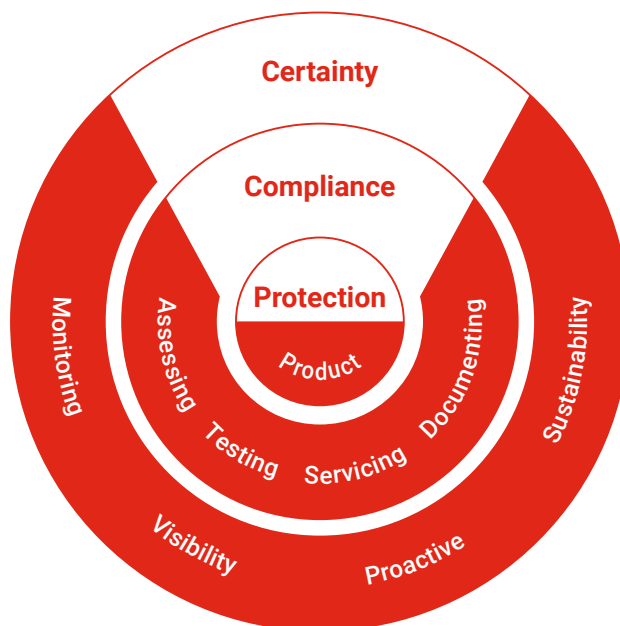

FALCON - A CLOUD-BASED SAFETY MANAGEMENT SYSTEM

Do you want assurance that your emergency shower system is fully functional 24/7? And would you like to ensure that your tests are conducted professionally and in compliance with applicable standards? If yes, then FALCON is the solution for you. FALCON is a comprehensive safety management system that transforms your emergency shower system, providing the security you need to prioritize employee safety and ensure continuous, effective safety measures.

FALCON provides:

- » **Monitoring** - FALCON provides a complete overview as it monitors and collects data from all your showers in real-time – even across multiple buildings and locations.
- » **Visibility** - FALCON helps streamline maintenance with planning tools, route recommendations, system deviation notifications, and easy report generation for compliance. A webhook feature allows FALCON to integrate with other BMS systems, enhancing functionality and automation.
- » **Proactive** - FALCON makes it easy to maintain a high level of employee safety. The system sends notifications to selected employees via phone and email if an emergency shower is activated, alerting them that a colleague may need assistance.
- » **Sustainability** - With quick testing results, FALCON can reduce water consumption by up to 50%. Its easy installation requires no cabling, and the system is compatible with both BROEN-LAB and non-BROEN-LAB emergency showers, offering flexibility and efficiency.

HARDWARE

A complete FALCON system consists of:

- A) Sensor Module**
- B) Communication Module**
- C) Sensor Cable**

These modules are installed/placed at each emergency shower unit. Each sensor module contains a flow switch, flow meter, pressure sensor, and temperature sensor. Data from the sensor module is sent via the battery-powered communication module to the FALCON data center in the cloud through an independent 4G LTE network.

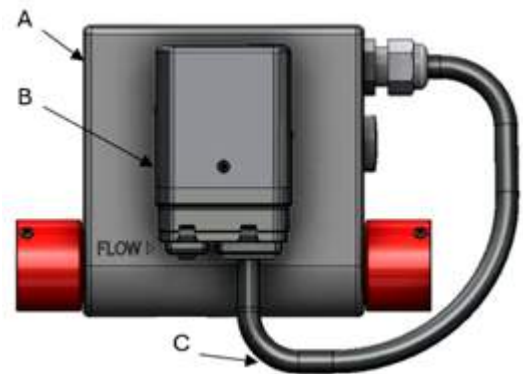

TECHNICAL INFORMATION

BROEN-LAB item no.	Inlet/outlet	Max. working pressure	Min. flowrate	Max. flowrate	Max. working temperature
27500011000001	1"/1" smart plug	PN10	10 l/min.	90 l/min.	90°C
27500021000001	3/4"/1" smart plug	PN10	10 l/min.	90 l/min.	90°C
27500031000001	1/2"/1" smart plug	PN10	10 l/min.	90 l/min.	90°C



Download app
for IOS



Download app
for Android

For more information and technical datasheets please contact your BROEN-LAB sales representative.



HAND-HELD EYE SHOWERS

BROEN-LAB has developed hand-held eye showers, which comply to EN15154-2 and ANSI Z358.1 norms and also offer many improved features.



MATERIALS WITH MEDIA CONTACT
 Plastics: PA, POM, TPE
 Metals: SS, AISI 316
 Rubber: EPDM

SAFETY

- Improved trigger lock
- Improved shower activation
- BROEN-LAB recommends the installation of a Thermostatic Mixing Valve (TMV) with shower equipment for safer operation. See page 13 for more information.

OPERATION

- Stay-open dust cap
- Light weight
- Well-balanced construction
- Spray pattern

RELIABILITY

- Easy-to-clean spray head
- Anti-limescale design and material
- Improved functionality
- Long lifetime



reddot design award
winner 2013

EMERGENCY SHOWER SYSTEMS

Eye Shower with Two 45° Heads



No. 27 10 009 10 05 011

Weight: Approx. 0.5 kg

Table mounted eye shower with two 45° angled heads, incl. 1.5m inlet hose. Trigger operated including a built-in check valve and FLOWFIX for regulation of water flow (14 l/min).
 Min. working pressure: 1,5 bar.

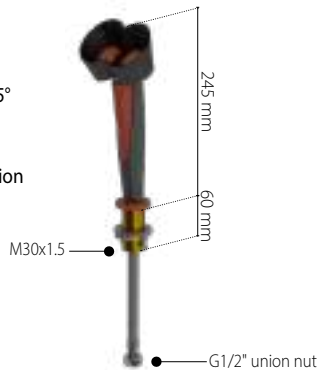

Eye Shower with Two 45° Heads



No. 27 10 009 10 03 011

Weight: Approx. 0.5 kg

Wall mounted eye shower with two 45° angled heads, incl. 1.5m inlet hose. Trigger operated including a built-in check valve and FLOWFIX for regulation of water flow (14 l/min).
 Min. working pressure: 1,5 bar.

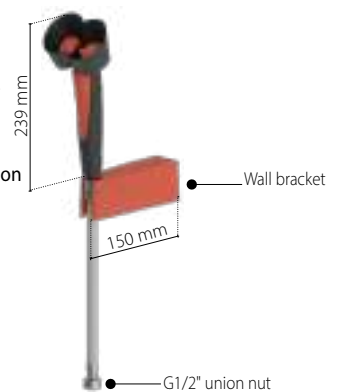

Eye Shower with a Single 45° Head



No. 27 10 003 10 05 011

Weight: Approx. 0.5 kg

Table mounted eye shower with a single 45° head, incl. 1.5m inlet hose. Trigger operated including a built-in check valve and FLOWFIX for regulation of water flow (7 l/min).
 Min. working pressure: 1,5 bar.

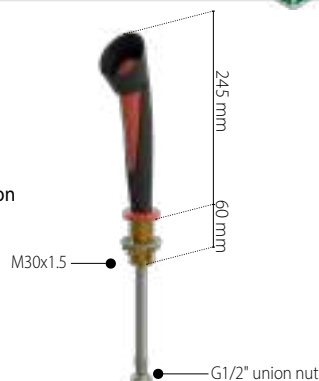

Eye Shower with a Single 45° Head



No. 27 10 003 10 03 011

Weight: Approx. 0.5 kg

Wall mounted eye shower with a single 45° head, incl. 1.5m inlet hose. Trigger operated including a built-in check valve and FLOWFIX for regulation of water flow (7 l/min).
 Min. working pressure: 1,5 bar.

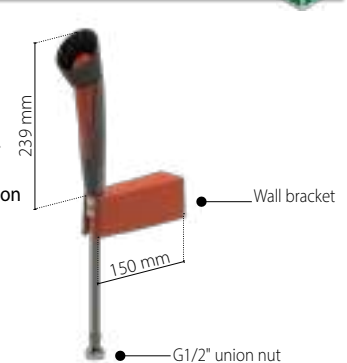

Other configurations are possible - please refer to ordering information on page 6.

HAND-HELD EYE SHOWERS AND ACCESSORIES

Eye Shower with a Single 45° Head

No. 27 10 003 10 00 001

Weight: Approx. 0.2 kg

Eye shower with a single head. Trigger operated including a built-in check valve and FLOWFIX for regulation of water flow (7 l/min). Also available as straight model.



Eye Shower with Two 45° Heads

No. 27 10 009 10 00 001

Weight: Approx. 0.2 kg

Eye shower with two angled heads. Trigger operated including a built-in check valve and FLOWFIX for regulation of water flow (14 l/min). Also available as straight model.



ACCESSORIES FOR HAND-HELD EYE SHOWERS

Mounting Accessories (YY):

No. 17 760 300
Table base (M30x1.5, 60mm)



No. 17 760 310
30° Wall base



No. 17 760 320
Wall bracket



No. 17 760 330
Bracket for modular body shower



Signs and Instructions (YY):

No. 17 001 970
Complete set with signs and instructions for eye shower



No. 96M0339
Sign for eye shower (sticker)



Hoses and hose accessories (ZZ):

No. 93H40561500
1.5m Silicone hose with a Stainless Steel braiding and Swivel Joint for hand-held eye showers.



(other lengths on request).

No. 17701760
Counter weight/stop for hose

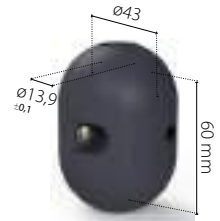

EMERGENCY SHOWER SYSTEMS

ORDERING INFORMATION

For ordering a complete hand-held eye shower including accessories, please follow the following structure:

27 10 XXX 10 YY ZZ 1

Serial number

- 001 - Rinsing model, 45° *
- 003 - Eye Shower, single, 45°
- 004 - Rinsing model, straight
- 006 - Eye shower, single, straight
- 009 - Eye shower, double, 45°
- 012 - Eye shower, double, straight

Country code

- 10 - International

* Accessories

- 00 - None *
- 01 - 17 001 970
- 02 - 96M0339
- 03 - 17 001 970 + Wall bracket
- 04 - 17 001 970 + 30° Wall Base
- 05 - 17 001 970 + Table base
- 06 - 96M0339
- 07 - 96M0339 + 30° Wall Base
- 08 - 96M0339 + Table base
- 09 - 96M0339 + Bracket for modular body shower
- 10 - 1776032 - Wall bracket *

* Hose length + Hose accessory

- 00 - None
- 01 - 1.5m with G1/2 union nut
- 02 - 1.5m with G1/2 union nut + stop
- 03 - 2m with G1/2 union nut
- 04 - 2m with G1/2 union nut + stop

* Please request document No. 99G0045 for a complete list of available hoses and accessories.

For more information and technical datasheets please contact your BROEN-LAB sales representative.

EYE/FACE SHOWERS

BROEN-LAB has developed the Eye/Face showers, which comply to EN15154-2 and ANSI Z358.1 norms and also offer many improved features.



MATERIALS WITH MEDIA CONTACT

Plastics: TPE
Metals: Brass
Rubber: EPDM

SAFETY

- Flow rate in according to EN15154-2
- BROEN-LAB recommends the installation of a Thermostatic Mixing Valve (TMV) with shower equipment for safer operation. See page 13 for more information.
- Sign according to ISO 3864-1

OPERATION

- Stay-open dust cap
- Plug and play assembly
- Spray pattern according to EN15154-2
- Stronger wall flange with 6 holes for wall mounted models

RELIABILITY

- Easy-to-clean spray head
- Anti-limescale design and material
- Improved functionality
- Long lifetime

Eye/Face Shower with Bowl, Wall Mounted



Weight: Approx. 5.5 kg

Eye/Face shower with two heads in brass with chemical resistant BROEN-LAB Polycoat and Stainless Steel bowl. Wall mounted for exposed pipe work. The water amount is regulated by a built-in FLOWFIX (16 l/min). Min. working pressure: 1,5 bar.

No. 17 528 009

No. 17 528 009E
Includes a 700 mm connection hose with union nut 1/2" inlet. More information, see page 15

Other Models

No. 17 533 009
Inlet: G1/2" male (60mm)

Anti-corrosive

No. 17 528 004

Inlet: G3/4" female

No. 17 533 004

Inlet: G1/2" male (60mm)

Eye Shower, Wall Mounted

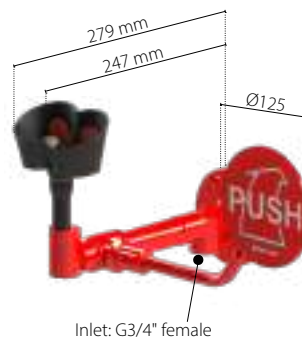

No. 17 550 009

No. 17 550 009E
Includes a 700 mm connection hose with union nut 1/2" inlet. More information, see page 15

Weight: Approx. 2.5 kg

Eye shower, wall mounted in brass with chemical resistant BROEN-LAB Polycoat. The water is regulated with a built-in FLOWFIX (16 l/min). Min. working pressure: 1,5 bar.

Eye Shower, Table Mounted, Swing Down

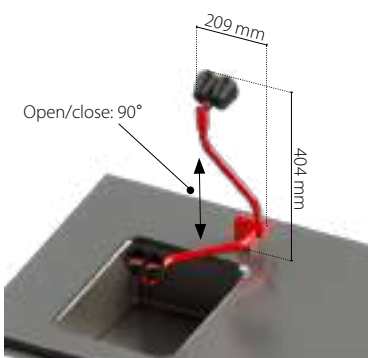

Weight: Approx. 2.5 kg

Eye shower, table mounted on right side of sink, swing down in brass with chemical resistant BROEN-LAB Polycoat for mounting on back side of the sink. The water amount is regulated with built-in FLOWFIX (16 l/min). Min. working pressure: 2 bar.

No. 17 527 009

Other Models

No. 17 526 009
Mounting on left side of sink

No. 17 542 009
Swing down wall mounted version

Eye Shower, Table Mounted, Swivel Joint

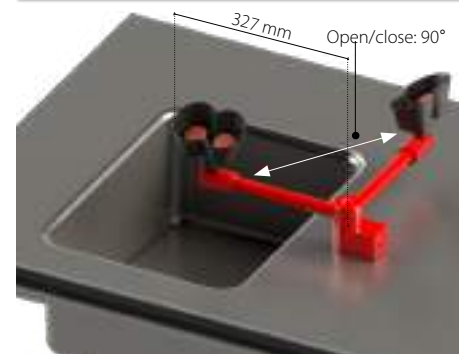

Weight: Approx. 2.5 kg

Eye shower, table mounted, swivel joint in brass with chemical resistant BROEN-LAB Polycoat for mounting on the right side of sink. The water amount is regulated with the built-in FLOWFIX (16 l/min). Min. working pressure: 2 bar.

No. 17 531 009

Other Models

No. 17 530 009
For mounting to the left of sink

RECESSED EMERGENCY SHOWERS

SPECIAL FEATURES

GENERAL:

- Several modules available based on modules shown to the right.
- Choose between BROEN-LAB Polycoated surface or Anti Corrosive.
- Cabinet and cabinet door in Stainless Steel AISI 316L.
- Disability-Friendly models comply with ANSI A117.1-2003.
- Easy to mount and install.
- Cabinet can also be surface mounted with exposed piping. Separate frame unit can be ordered.

Choose among different body shower outlets by ordering recessed units and outlets separately to fit your exact needs of installation and application.

E.g. : 17 157 009 + 17 110 009



EYE WASH:

- Cabinet and cabinet door in Stainless Steel AISI 316L.
- Integrated drain.
- Cabinet door catches the water and prevents it from splashing on the floor.

BODY SHOWER:

- Strong integrated handle for operating body shower.
- Free choice of combination between ceiling or wall mounted body shower outlet.
- Premounted valve for body shower.

Body Shower Outlet, Ceiling Mounted, Concealed

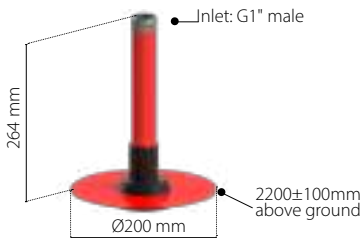

No. 17 100 009

Other Models

Anti-corrosive

No. 17 100 004



Weight: Approx. 1 kg

Body shower outlet, ceiling mounted, concealed in Stainless Steel with self-draining shower head.

Working pressure is given on pre-assembled valve for body shower.

Body Shower Outlet, Ceiling Mounted

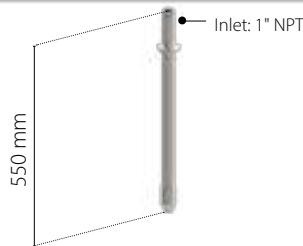

No. 17 901 830

Weight: Approx. 1 kg

Body shower outlet, ceiling mounted, concealed in Stainless Steel with self-draining shower head.

Working pressure is given on pre-assembled valve for body shower.

Body Shower Outlet, Wall Mounted

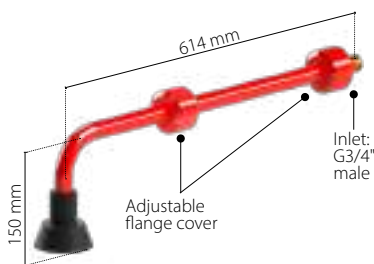

No. 17 120 009

Other Models

No. 17 088 009
Male inlet and fixed flange

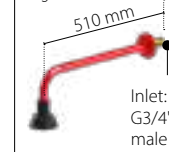

Weight: Approx. 1.5 kg

Body shower outlet, wall mounted, in brass with chemical resistant BROEN-LAB Polycoat with self-draining shower head. Inlet G 3/4" male.

Working pressure is given on pre-assembled valve for body shower.

Body Shower Outlet, Ceiling Mounted

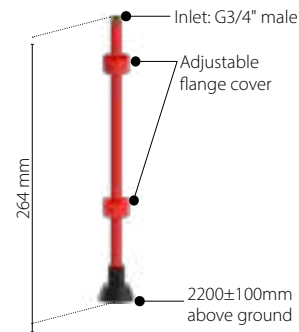

No. 17 110 009

Other Models

No. 17 089 009
Male inlet and fixed flange

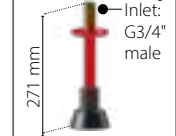

Anti-corrosive

Same as ill. Polycoat but anti-corrosive.
No. 17 110 004

Male inlet and fixed flange
No. 17 089 004

Weight: Approx. 1.5 kg

Body shower outlet, ceiling mounted, in brass with chemical resistant BROEN-LAB Polycoat with self-draining shower head. Fits different ceiling heights by adjusting the flange. Inlet G 3/4" male.

Working pressure is given on pre-assembled valve for body shower.

Body Shower Outlet, Wall Mounted

Anti-corrosive



Disability-Friendly

No. 17 130 004

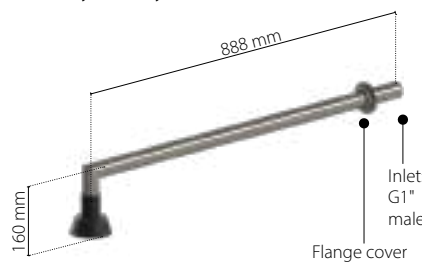

Weight: Approx. 1.5 kg

Wall mounted body shower outlet in Stainless Steel AISI 304, with self-draining shower head. Inlet G 1" male. With adjustable flange.

Dimensions comply with the requirements of ANSI A117.1-2003.

Working pressure is given on pre-assembled valve for body shower.

Other Models

No. 17 088 004
Male inlet and fixed flange. Stanniloy



RECESSED EMERGENCY SHOWERS

Eye Shower, Wall Recessed

Anti Corrosive



Disability-Friendly

No. 17 156 009-3289

No. 17 156 009
Stainless Steel version



Weight: Approx. 10 kg

Eye shower, wall recessed, disability-friendly with cabinet in Stainless Steel AISI 316L with chemical resistant BROEN-LAB Polycoat, two outlet heads and built-in FLOWFIX (16 l/min). Cabinet door activates the eye wash and catches the water. Min. working pressure: 2 bar.

Eye and Body Shower, Wall Recessed

Anti Corrosive



Disability-Friendly

No. 17 157 009-3289

No. 17 157 009
Stainless Steel version

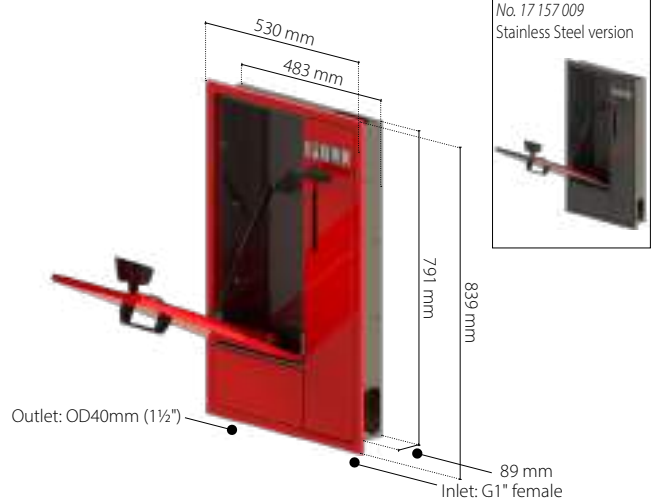

Weight: Approx. 16 kg

Eye shower, with 1" valve for body shower, wall recessed, disability-friendly with cabinet in Stainless Steel AISI 316L with chemical resistant BROEN-LAB Polycoat, two outlet heads and built-in FLOWFIX (16 l/min). Cabinet door activates the eye wash and catches the water. Integrated hand activating 1" valve for body shower with various options for shower outlet. Min. working pressure: 2 bar.

Body Shower, Wall Recessed, Hand Activator

Anti Corrosive



No. 17 143 009-3289

No. 17 143 009
Stainless Steel version

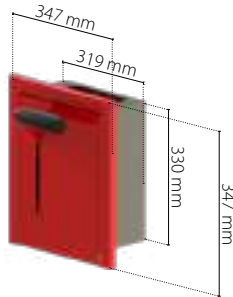

Weight: Approx. 2.5 kg

Wall recessed cabinet in Stainless Steel AISI 316L with chemical resistant BROEN-LAB Polycoat and hand activator for body shower with various options for shower outlet. 1" valve for 3/4" or 1" pipe. Min. working pressure: 1 bar.

ORDERING INFORMATION

- 17 1xx Y09 Stainless Steel cabinet with red inner parts
- 17 1xx Y09-3289 Powder coated in red Stainless Steel cabinet with red inner parts

Where XX refers to the model and Y to country code.

- Country code: 0 = international version with 40 mm drain
- 1 = US version with 2" NPT drain

BODY SHOWERS

BROEN-LAB has developed body showers, which comply with EN15154-1 and ANSI Z358.1 norms and also offer many improved features.



MATERIALS WITH MEDIA CONTACT

Plastics: PPO
Metals: Brass
Rubber: EPDM

SAFETY

- Flow rate in according to EN15154-1
- Spray pattern according to the EN 15154-1
- Sign according to ISO 3864-1
- BROEN-LAB recommends the installation of a Thermo-static Mixing Valve (TMV) with shower equipment for safer operation. See page 13 for more information.

OPERATION

- Plug and Play assembly
- Stronger wall flange with 6 holes for wall mounted models with exposed piping

RELIABILITY

- Plug and Play Spare Parts
- Anti-limescale design and material
- Improved functionality
- Long lifetime

Body Shower, Ceiling Mounted

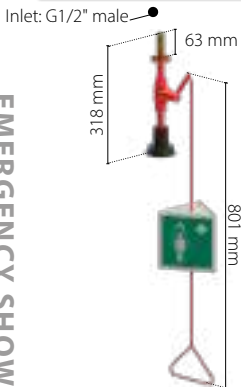

No. 17 580 009

Weight: Approx. 1.7 kg
Body shower, ceiling mounted with self-draining head. In brass with chemical resistant BROEN-LAB Polycoat.
Min. working pressure: 1 bar.

Body Shower, Wall Mounted

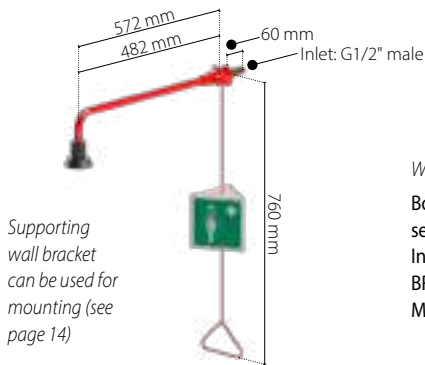

No. 17 581 009

Supporting wall bracket can be used for mounting (see page 14)

Weight: Approx. 2.5 kg
Body shower, wall mounted with self-draining shower head. In brass with chemical resistant BROEN-LAB Polycoat.
Min. working pressure: 1 bar.

Body Shower for Exposed Pipework, Wall Mounted

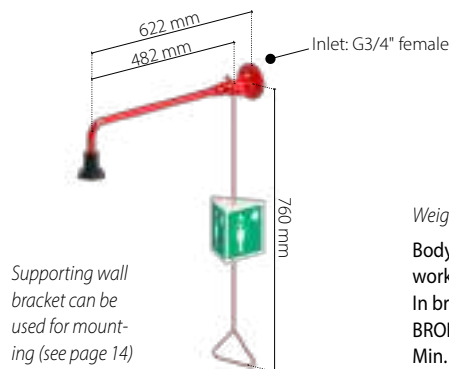

No. 17 582 009
No. 17 582 009E
Includes a 700 mm connection hose with union nut 1/2" inlet. More information, see page 15

Weight: Approx. 2.9 kg
Body shower for exposed pipe-work with self-draining head. In brass with chemical resistant BROEN-LAB Polycoat.
Min. working pressure: 1 bar.

Supporting wall bracket can be used for mounting (see page 14)

Body Shower, Wall Mounted above Door

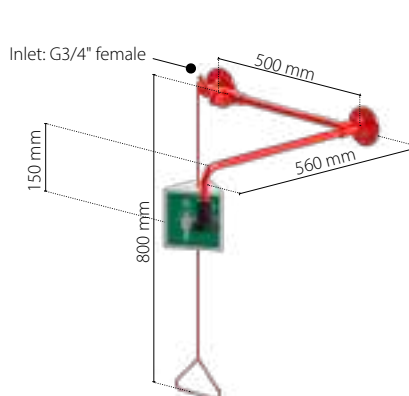

No. 17 587 009
No. 17 587 009E
Includes a 700 mm connection hose with union nut 1/2" inlet. More information, see page 15

Weight: Approx. 4.2 kg
Body shower, wall mounted above door for exposed pipework with self-draining head. In brass with chemical resistant BROEN-LAB Polycoat. Valve to be mounted left or right of door.
Min. working pressure: 1 bar.

Body Shower, Ceiling Mounted with ceiling flanges

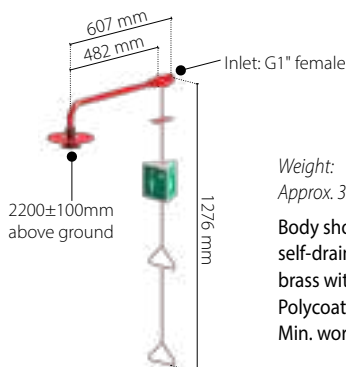

No. 17 660 009

Weight: Approx. 3.1 kg
Body shower, ceiling mounted with self-draining head and ceiling flange. In brass with chemical resistant BROEN-LAB Polycoat.
Min. working pressure: 1 bar.

Body Shower, Wall Mounted

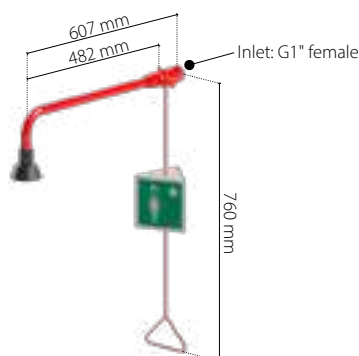

No. 17 575 009

Weight: Approx. 2.5 kg
Body shower, wall mounted with self-draining shower head. In brass with chemical resistant BROEN-LAB Polycoat.
Min. working pressure: 1 bar.

COMBINATION SHOWERS

Body Shower with Eye/Face Shower and Bowl, Modular

No. 17 656 009

No. 17 656 009E
Includes a 700 mm connection hose with union nut 1/2" inlet. More information, see page 15

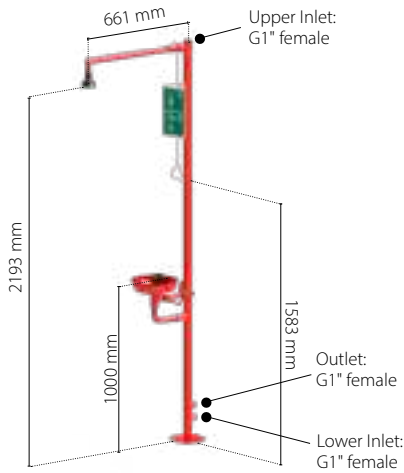

Weight: Approx. 18 kg

Body shower with eye/face shower and bowl, modular. In brass and SS with chemical resistant red BROEN-LAB Polycoat with self-draining shower head. Eye wash with built-in FLOWFIX for regulation of water flow (16 l/min). Bowl in Stainless Steel with integrated outlet. Min. working pressure: 1.5 bar.

Anti-corrosive - Modular

No. 17 656 004

Same as illustrated above but in anti-corrosive.

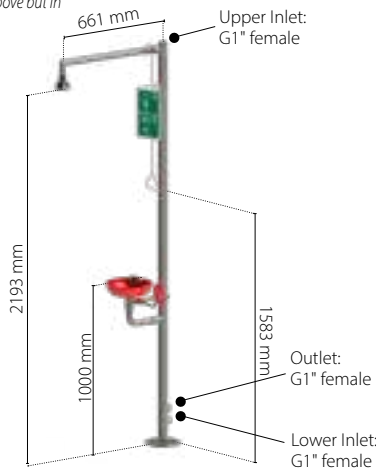

Body Shower with Eye/Face Shower and Bowl, Modular

No. 17 657 009



Disability-Friendly

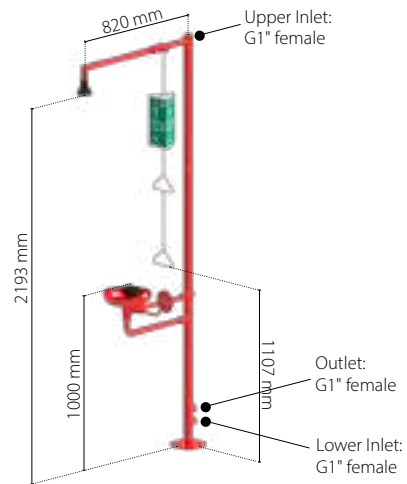

Weight: Approx. 19 kg

Body shower with eye/face shower and bowl, modular. In brass and SS with chemical resistant red BROEN-LAB Polycoat with self-draining shower head. Eye wash with built-in FLOWFIX for regulation of water flow (16 l/min). Bowl in Stainless Steel with integrated outlet. Min. working pressure: 1.5 bar.

Anti-corrosive - Modular

No. 17 657 004

Same as illustrated above but in anti-corrosive.

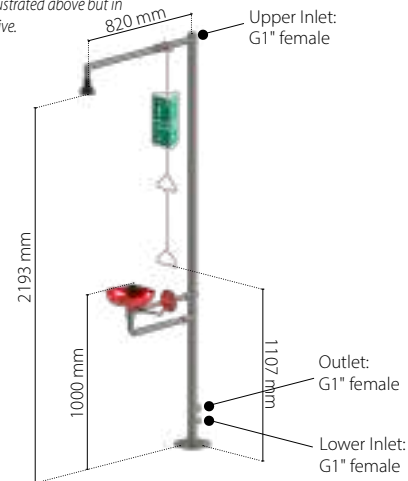

Disability-Friendly

Body Shower with Eye/Face Shower and Bowl, Modular

No. 17 556 009

No. 17 556 009E
Includes a 700 mm connection hose with union nut 1/2" inlet. More information, see page 15

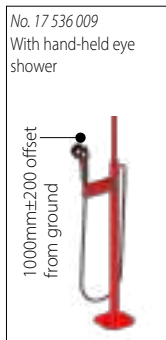
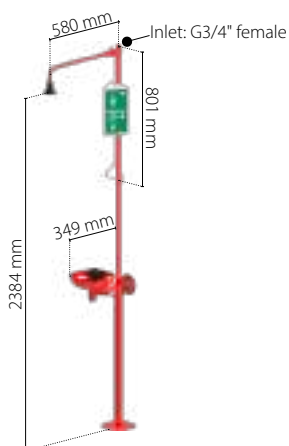

Weight: Approx. 14 kg

Body shower with eye/face shower and bowl, modular. In brass and SS with chemical resistant red BROEN-LAB Polycoat with self-draining shower head. Eye wash with built-in FLOWFIX for regulation of water flow (16 l/min). Bowl in Stainless Steel. Min. working pressure: 1.5 bar.

Body Shower with Eye/Face Shower and Bowl, Modular, Wall Mounted

No. 17 552 009

No. 17 552 009E
Includes a 700 mm connection hose with union nut 1/2" inlet. More information, see page 15

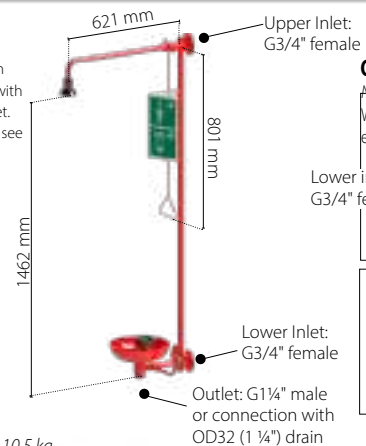

Weight: Approx. 10.5 kg

Body shower with eye/face shower and bowl, modular. In brass and SS with chemical resistant red BROEN-LAB Polycoat with self-draining shower head. Eye wash with built-in FLOWFIX for regulation of water flow (16 l/min). Bowl in Stainless Steel. Min. working pressure: 1.5 bar.

Other Models

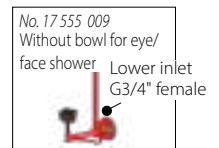
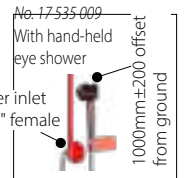

EMERGENCY SHOWERS IN STAINLESS STEEL (316L)

Body Shower for Exposed Pipework, Wall Mounted

No. 28233011021000

No. 28233011021000E
Includes a 700 mm connection hose with union nut 1/2" inlet. More information, see page 15.

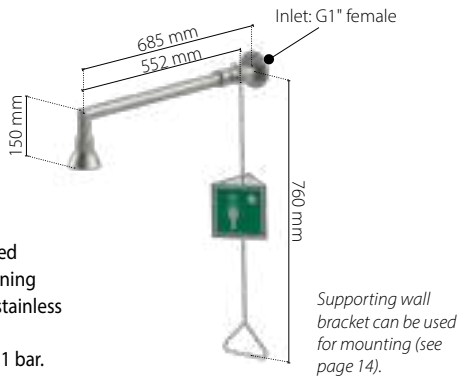

Weight: Approx. 3.9 kg

Body shower for exposed pipework with self-draining head. In acid-resistant stainless steel (316L).

Min. working pressure: 1 bar.

Body Shower for Exposed Pipework, Wall Mounted Above Door

No. 28243011021000

No. 28243011021000E
Includes a 700 mm connection hose with union nut 1/2" inlet. More information, see page 15.

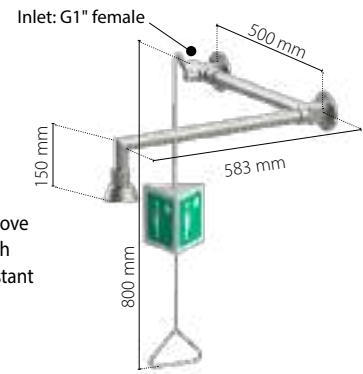

Weight: Approx. 6.2 kg

Body shower, wall mounted above door for exposed pipework with self-draining head. In acid-resistant stainless steel (316L). Optional valve mounting, left or right of door.

Min. working pressure: 1 bar.

Body Shower for Exposed Pipework, Wall Mounted

No. 28233011021001

Same as illustrated above; in acid-resistant stainless steel (316L), but with chemical resistant red BROEN-LAB Polycoat.

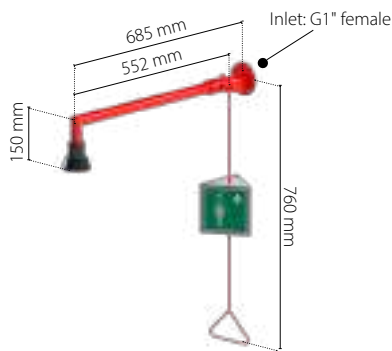

Body Shower with Hand-held Eye Shower, Freestanding

No. 28413011021000

No. 28413011021000E
Includes a 700 mm connection hose with union nut 1/2" inlet. More information, see page 15.

Weight: Approx. 19 kg

Body shower with hand-held eye shower, freestanding. In acid-resistant stainless steel (316L) with self-draining shower head. Eye shower with built-in check valve and FLOWFIX for regulation of water flow (14 l/min).

Min. working pressure: 1.5 bar.

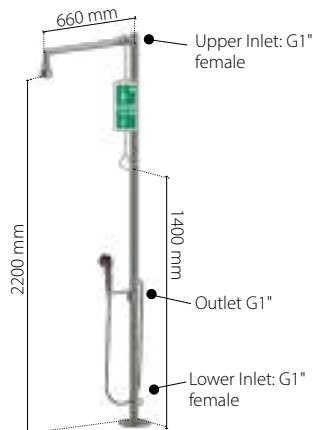

Body Shower for Exposed Pipework, Wall Mounted Above Door

No. 28243011021001

Same as illustrated above; in acid-resistant stainless steel (316L), but with chemical resistant red BROEN-LAB Polycoat.

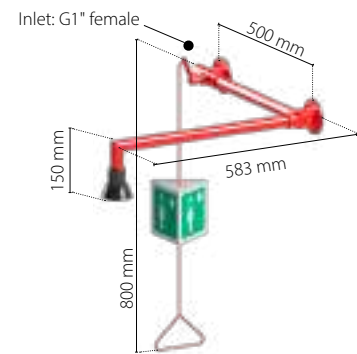

Body Shower with Hand-held Eye Shower, Wall Mounted

No. 28433011021000

No. 28433011021000E
Includes a 700 mm connection hose with union nut 1/2" inlet. More information, see page 15

Weight: Approx. 13,6 kg

Body shower with hand-held eye shower, wall mounted. In acid-resistant stainless steel (316L) with self-draining shower head. Eye shower with built-in check valve and FLOWFIX for regulation of water flow (14 l/min).

Min. working pressure: 1.5 bar.

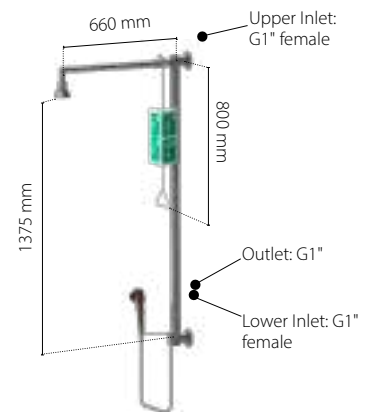

Body Shower with Hand-held Eye Shower, Freestanding

No. 28413011021001

Same as illustrated above; in acid-resistant stainless steel (316L), but with chemical resistant red BROEN-LAB Polycoat.

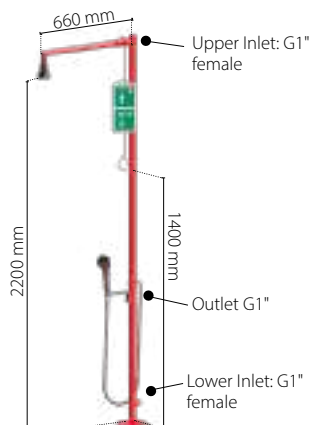

Body Shower with Hand-held Eye Shower, Wall Mounted

No. 28433011021001

Same as illustrated above; in acid-resistant stainless steel (316L), but with chemical resistant red BROEN-LAB Polycoat.

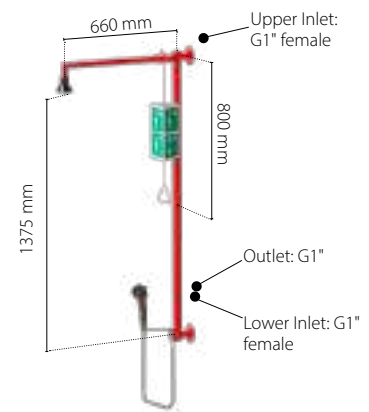

ACCESSORIES FOR EMERGENCY SHOWER SYSTEMS

Thermostatic Mixing Valves for Emergency Shower Systems

BROEN-LAB TMVs for eye and body showers are thermostatic mixing valves designed for delivering tepid water (22-28°C) for eye/hand or body showers.

The Thermostatic Mixing Valve solution is designed for the operation of one eye/hand shower or one body shower, respectively.

The water temperature is set to tepid per our factory.

The TMV incorporates in one body the following features:

- Hot-Water Fail Safe: If the cold water is interrupted, the built-in anti-scalding device will automatically cease the flow of hot water.
- Cold Water Fail-Safe: If the hot water is interrupted, the built-in intentional leak will allow cold water to flow at a sufficient flowrate to ensure operation. THIS WORKS AUTOMATICALLY AS WELL
- Includes check valves on both hot and cold supply

Thermostatic Mixing Valves for Eye Shower



No. 2703 007 1035: Model with G1/2" male inlet Thermostatic mixing valve for eye shower with bracket. Min. working pressure: 1 bar.

No. 2703 009 1035: Model with G3/4" female inlet Thermostatic mixing valve for eye shower without bracket. Min. working pressure: 1 bar.

Thermostatic Mixing Valves for Body- and Combination Showers

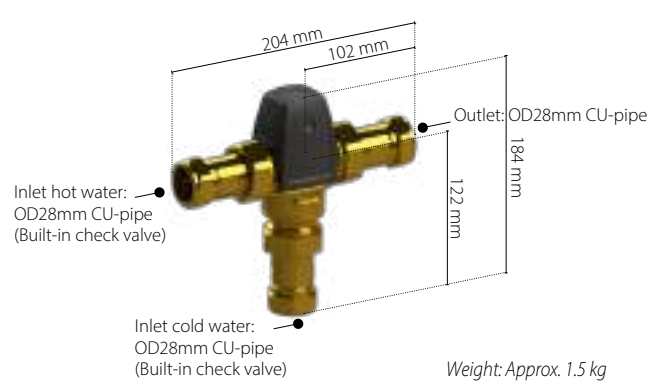

No. 17 512 009: Thermostatic mixing valve for body and Eye shower. Min. working pressure: 1.5 bar.

No. 17 513 009: Model with R1" inlet/outlet connections

Signs for Emergency Shower Systems

Nr. 17 001 920

(Weight: Approx. 0.23 kg)
Sign (pull rod mounted) and instruction card for Body and Eye Shower



Nr. 17 002 27

(Weight: Approx. 0.03 kg)
Instruction and Service Sign - Body Shower



Nr. 96M0042

(Weight: Approx. 0.01 kg)
Sign for body shower (sticker)



Nr. 17 001 910

(Weight: Approx. 0.13 kg)
Sign (pull rod mounted) and instruction card for Body Shower



Nr. 17 002 28

(Weight: Approx. 0.03 kg)
Instruction and Service Sign - Body and Eye Shower



Nr. 96M0043

(Weight: Approx. 0.01 kg)
Sign for eye shower (sticker)



Nr. 17 002 010

(Weight: Approx. 0.15 kg)
Sign (wall mounted) and instruction card for Body and Eye Shower



Nr. 17 002 29

(Weight: Approx. 0.03 kg)
Instruction and Service Sign - Eye Shower fountain



Nr. 96M0345

(Weight: Approx. 0.01 kg)
Sign for direction (sticker)



Nr. 17 001 900

(Weight: Approx. 0.08 kg)
Sign (wall mounted) and instruction card for Eye Shower



Nr. 17 002 30

(Weight: Approx. 0.03 kg)
Instruction and Service Sign - Eye Shower - Hand-Held



Nr. 96M0366

(Weight: Approx. 0.5 kg)
Sticker for floor indicates the area that should remain cleared



Nr. 17 002 000

(Weight: Approx. 0.08 kg)
Sign (wall mounted) and instruction card for Body Shower



ACCESSORIES FOR EMERGENCY SHOWERS

Cable

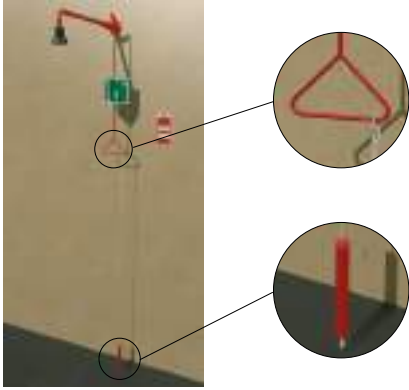

No. 17 901 64
A cable may be installed as a supplement to the pull rod, this enables the user to activate the shower at floor level

Wall bracket for body showers

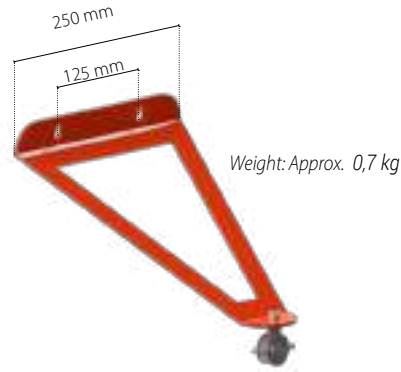

No. 17 001 079 1/2", 17 001 099 1"
Wall bracket for support of wall mounted body showers (size 1/2" or 1").

Flowfix regulator unit



Unit to reduce the water flow of a combination or body shower.

Item no.	Flowrate	Colour of flowfix (inside unit)
17 552 239	50 l/m.	Red
17 552 249	70 l/m.	Ligth blue
17 552 259	90 l/m.	Blue

Alarm for Emergency Shower



No. 17 851 95
Signal and light alarm for emergency showers.
- 112dB(A) output
- IP66 protection
- 32 alarm tones
Working temperature: -20°C to 70°C
Power supply: 230VAC, 50/60Hz

For operation in Non Ex Proof areas (also available for Ex Proof areas)

Foot Treadle for Operation of Eye Showers



No. 17 909 909
Foot treadle in aluminium and SS for the operation of eye showers. It is possible to combine with 17 919 009 if mounted 180° opposite. Delivered with all mounting accessories. (see page 24)

Flow switch



Weight: Approx. 0,5 kg

- Good reliability
- Low pressure loss
- Dirt resistant
- Hermetic separation of electrical and hydraulic components

Item no.	Material	Size*	PN, bar
96P0062	brass	G3/4	25
96P0063	brass	G 1 1/4	25
96P0066	SS	G3/4	25
96P0068	SS	G 1 1/4	25

* Please note that size of the flow switch should be a size bigger than the inlet of the emergency shower

When there is a stream of water in the connection piping to the emergency shower, the paddle in the flow switch triggers an electrical reed switch. This switch can be connected to any type of warning system, such as an alarm central, a horn, a light or similar.

For operation in Non Ex Proof areas (also available for Ex Proof areas)

For more information and technical datasheets please contact your BROEN-LAB sales representative.



The standard 700 mm connection hose with G1/2" union nut is suitable for all new models with female G3/4". For other requirements, do not hesitate to contact BROEN-LAB.



Easy to install on current pipes

At BROEN-LAB we focus on quality in every detail to help you work smarter while reducing installation time.



No teflon tape or hemp is needed

work smarter while reducing installation time. Therefore no Teflon tape is needed.



O-ring sealing

The O-ring reduces the risk of leakage and improves safety functions.



See how easy it is to connect

Connection hoses for Emergency Showers

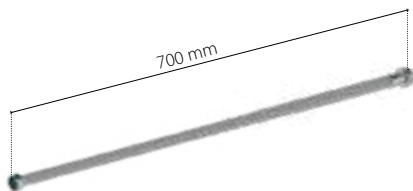

- No. 93i59370700 (Male G1" - Female G1" union nut connection)
- No. 93i59330700 (Male G3/4" - Female G1" union nut connection)
- No. 93i42330700 (Male G3/4" - Female G3/4" union nut connection)
- No. 93i42370700 (Male G1" - Female G3/4" union nut connection)

Material: Silicone
 Braiding: Stainless Steel
 Inside diameter: Ø15mm
 Outside diameter: Ø21,5mm
 Max.working pressure: 10 bar
 Max.working temperature: 90°C

Drain kit for Emergency Showers

No. 17 556 579

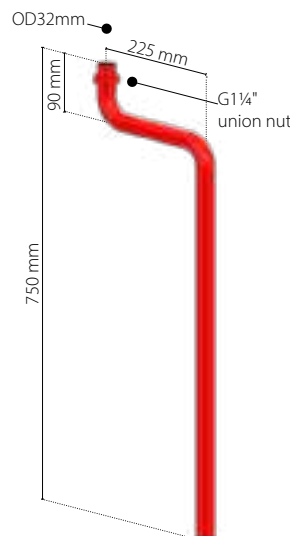

For extra drainage under bowl on body showers with eye/face wash and bowl.

- Compatible with:
- 17 552 009
 - 17 528 009 + 17 528 004
 - 17 541 009 + 17 541 004
 - 17 556 009
 - 17 533 009 + 17 533 004
 - 17 653 009 + 17 653 004

TEST EQUIPMENT FOR EMERGENCY SHOWER SYSTEMS

Test Trolley for Emergency Showers

No. 27570211000001, model with integrated pump

*With 8 mm connection cable and international plug

Test trolley with integrated pump.

Drainage hose is included. Capacity: 90 l

Can be used for heated and unheated emergency showers.

Weight: Approx. 37,5 kg



For operation in Non Ex Proof areas.

Test Funnel for Emergency Showers

No. 17 001 08

Test funnel for testing of emergency showers in PC (polycarbonate) with 2.2m hose.

No. 27 99 008 10 01

Measuring Cylinder for checking Eye Wash Stations



FIRST AID KIT

P7330051000002



Standard First Aid Kit which contains

- Clean pads
- Cool pads
- Stop dressing
- Elastic band aids x 2
- Sterile eye wash
- pH eye wash
- Signs
- instruction sheets
- First Aid Plans

It's also possible to configure you own First Aid Kit using the refill components beneath. For help please contact your BROEN-LAB representative.

REFILLS

Quick Clean

P7530071000000



Sterile wipes are ideal to clean skin and wound prior to dressing.

Quick Stop

P7530081000000



Wound dressing kit used to protect wound form further harm.

Quick Cool

P7530061000000



Burn gel that eases the pain if the skin has been in contact with hot surfaces or substances.

pH Neutral Eye Wash

P7170031000000



PH Neutral features phosphate buffer property with documented efficiency in chemicals-based eye injuries.

Elastic Plaster

P7530031000000



Elastic plasters that conform the movement of the skin so they are comfortable to use. The plasters are extremely skin-friendly and allow the skin to breathe.

Sterile Eye Wash

P7170021000000



Sterile Eye wash for optimum assistance if dirt, dust or other substances come in contact with eyes.

For more information and technical datasheets please contact your BROEN-LAB sales representative.

INTRODUCTION

Thousands of industrial accidents happen every year in spite of precautionary safety measures, accidents that are caused by human exposure to heat (fire, boiling water and oil, steam, etc.), to corrosive agents (fluid acids and caustics) and/or to influence by dust and corrosive aerosols (metal, dirt, fluids).



These accidents cause acute pain, disablement, and may even lead to loss of life. However, experience shows that the consequences and human suffering following such accidents can be considerably limited if water is applied directly to the affected areas instantly after the exposure.

The harsh reality is that risk lurks in many places: in the laboratory, in the kitchen, in the warehouse, in the chemical plant, in the workshop, or generally speaking in any place where heat, corrosion or dust can cause serious human injury. For these reasons we strongly recommend the installation of adequate emergency shower systems as a means of mitigating these risks.

Location and Operation of Emergency Showers

As a basic rule the shower must be located as close to the workplace as possible so that the general first aid instructions of flushing the affected area immediately after the accident has occurred can be followed.

Please note that if strong acids or caustics are involved, immediate action is required. Please also be aware that it must be easy to locate and access at all times for potential users.

BROEN-LAB Emergency Showers can be recognized by their red and white stripes on body and eye showers, red pull rods and luminescent signs and symbols for the clear identification of the emergency shower.

Selecting the Right Shower

There are many different conditions that determine the type of emergency shower to be installed. It is important that the chosen unit is designed and tested according to the existing standard as well as suits the specific application and location - **and environment!**



Tank showers - see page 21

Mobile and portable emergency showers - see page 22



Frost protected body showers - see page 18-19

In this section you can find a wide range of BROEN-LAB Emergency Showers that can be installed outside and be used in areas where outside temperatures go as low as -35°C.



FROST PROTECTED COMBINATION SHOWERS

Frost protected outdoor combination safety showers, trace tape heated, and pre-insulated. Delivered with eye/facewash fountain and additional eyebath diffuser on flexible hose to treat unconscious or disabled personnel.

Frost Protected Body Shower - Free Standing with Eye Wash Fountain

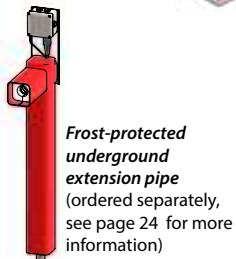
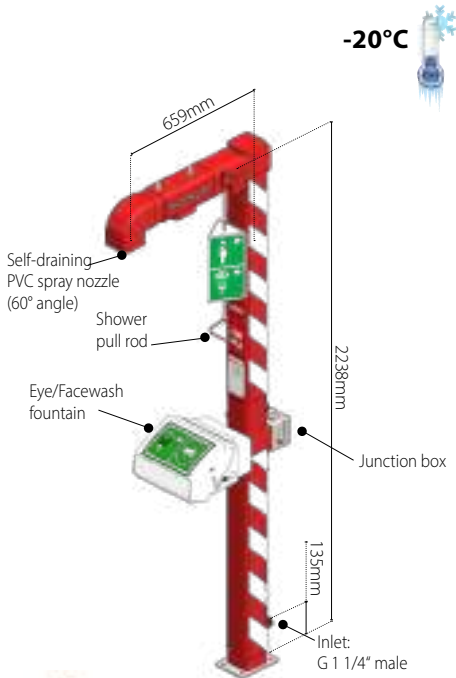

TECHNICAL SPECIFICATIONS

Min. working pressure: 2 Bar
 Min. working temperature: -20°C
 Water Flow: 115 l/min.
 Supply voltage: 230 VAC, 50/60 Hz
 Power consumption: 57W

Frost Protected Body Shower – Wall mounted with Eye Wash Fountain

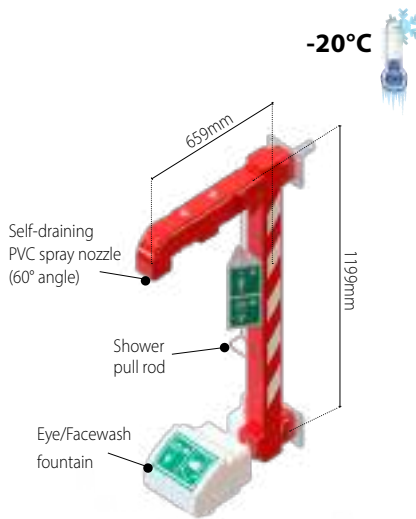

TECHNICAL SPECIFICATIONS

Min. working pressure: 2 Bar
 Min. working temperature: -20°C
 Water Flow: 115 l/min.
 Supply voltage: 230 VAC, 50/60 Hz
 Power consumption: 21W

Frost Protected Body Shower - Free Standing with Eye Wash Fountain

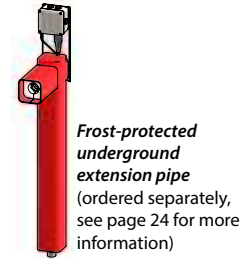
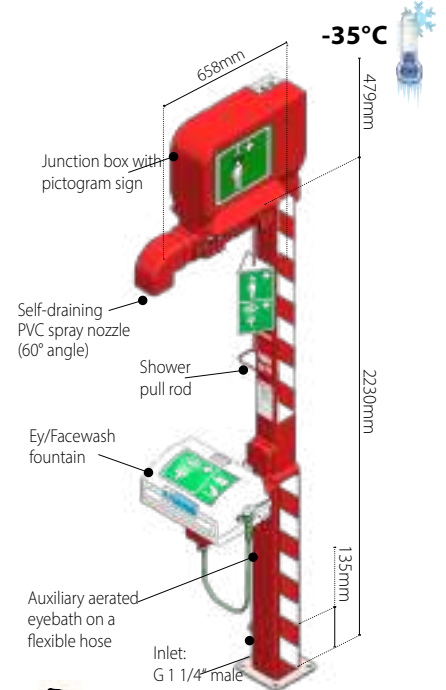

TECHNICAL SPECIFICATIONS

Min. working pressure: 2 Bar
 Min. working temperature: -35°C
 Water Flow: 115 l/min.
 Supply voltage: 230VAC, 50/60Hz
 Power consumption: 100W

EMERGENCY SHOWER SYSTEMS

ORDERING INFORMATION

BROEN-LAB item no.	Material	 Ex-proof*	Min. working temperature	Eye wash fountain	Mounting	Frost-protected underground extension pipe
H7 41 002 10 00 221	Stainless Steel	Yes	-20°C	Yes	Floor	Available
H7 43 001 10 00 221	Stainless Steel	Yes	-20°C	Yes	Wall	-
H7 41 001 10 00 231	Stainless Steel	No	-35°C	Yes	Floor	Available
H7 41 001 10 00 241	Stainless Steel	Yes	-35°C	Yes	Floor	Available

*Ex-proof zone 1 and zone 2.

For more information and technical datasheets please contact your BROEN-LAB sales representative.

FROST PROTECTED BODY SHOWERS

Frost protected outdoor combination safety showers, trace tape heated, and pre-insulated.

Frost Protected Body Shower - Free Standing

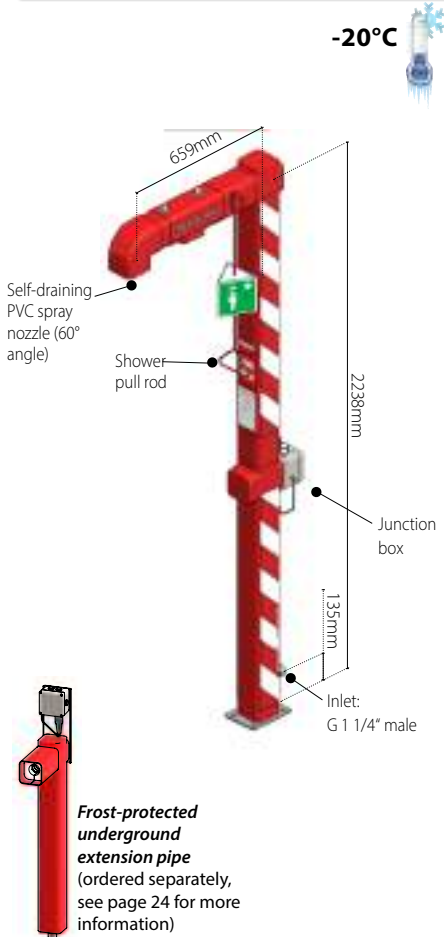

Frost Protected Body Shower - Free Standing

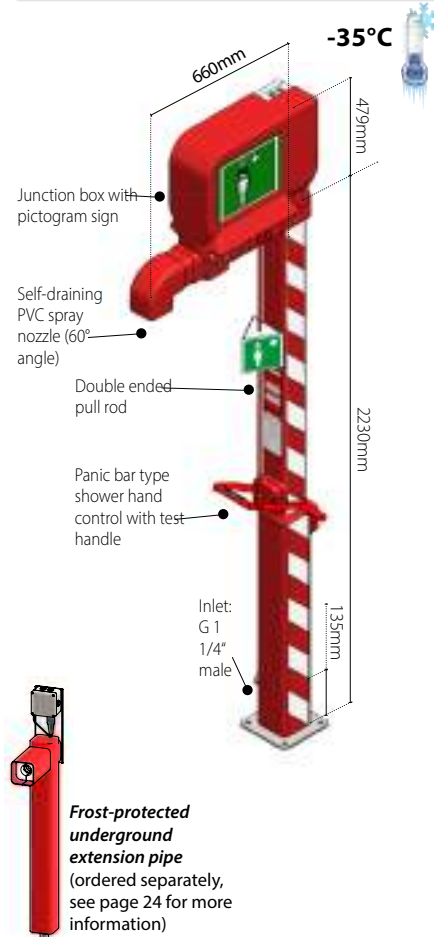

Frost Protected Body Shower - Wall Mounted

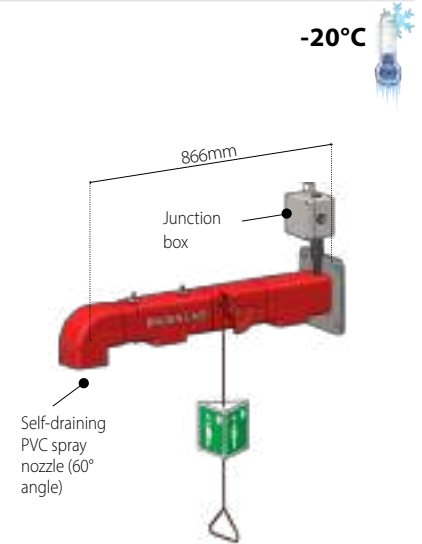

TECHNICAL SPECIFICATIONS

Min. working pressure: 2 Bar
 Min. working temperature: -20°C
 Water Flow: 115 l/min.
 Supply voltage: 230VAC, 50/60Hz
 Power consumption: 57W

TECHNICAL SPECIFICATIONS

Min. working pressure: 2 Bar
 Min. working temperature: -35°C
 Water Flow: 115 l/min.
 Supply voltage: 230VAC, 50/60Hz
 Power consumption: 100W

TECHNICAL SPECIFICATIONS

Min. working pressure: 2 Bar
 Min. working temperature: -20°C
 Water Flow: 115 l/min.
 Supply voltage: 230VAC, 50/60Hz
 Power consumption: 21W

ORDERING INFORMATION

BROEN-LAB item no.	Material	Ex-proof*	Min. working temperature	Eye wash fountain	Mounting	Frost-protected underground extension pipe
H7 21 002 10 00 221	Stainless Steel	Yes	-20°C	No	Floor	Available
H7 21 001 10 00 241	Stainless Steel	Yes	-35°C	No	Floor	Available
H7 21 001 10 00 231	Stainless Steel	No	-35°C	No	Floor	Available
H7 23 001 10 00 221	Stainless Steel	Yes	-20°C	-	Wall	-

*Ex-proof zone 1 and zone 2.

For more information and technical datasheets please contact your BROEN-LAB sales representative.

FROST PROTECTED EYE/FACE SHOWERS

Frost Protected Eye Wash Fountain, Pedestal Mounted

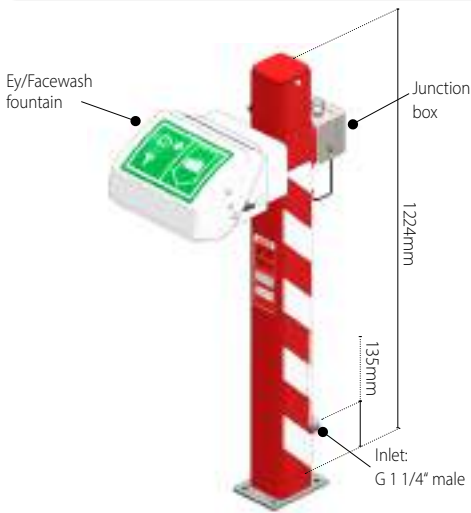

Outdoor pedestal mounted emergency eye/facewash fountain, trace tape heated and pre-insulated. Delivered with “unbreakable” integral lid, aerated diffusers, flow regulator and self-adhesive sign.

TECHNICAL SPECIFICATIONS

Min. working pressure: 2 Bar
 Min. working temperature: -20°C
 Water Flow: 20 l/min.
 Supply voltage: 230VAC, 50/60Hz
 Power consumption: 36W

Frost-protected underground extension pipe (ordered separately, see page 24 for more information)



ORDERING INFORMATION

BROEN-LAB item no.	Material	 Ex-proof*	Min. working temperature	Mounting	Frost-protected underground extension pipe
H7 31 001 10 00 221	Stainless Steel	Yes	-20°C	Floor	Available

*Ex-proof zone 1 and zone 2.

HEATED TANK SHOWERS

A range of heavy duty emergency tank showers, for use when warm water is required, or a constant supply of water cannot be guaranteed.

These units are essential where there is a lack of water pressure or inadequate flow rate. This improved range incorporates models to suit a wide range of situations.

Body Shower with Eye Wash Fountain & 1200 l tank



STANDARD CONFIGURATION

- 1200 l tank in medium density polythene
- Support legs and frame in Stainless Steel
- Rear and side GRP panelling
- Visual level indicator
- Body shower
- Eye/facewash fountain
- Shower control panic bar
- Foot panel for body shower

TECHNICAL SPECIFICATIONS

Min. working temperature: -35°C
 Water Flow: 75 l/min.
 Supply voltage: 230VAC, 50/60Hz
 Power consumption: 3000W

The **1200 liter** models will meet the mentioned standards even without an external supply connected.

For areas with high outside temperatures models with chillers can be supplied.

Unheated models are also available.

EMERGENCY SHOWER SYSTEMS

ORDERING INFORMATION

BROEN-LAB item no.	Material	 Ex-proof*	Min. working temperature	Eye wash fountain	Tank volume
H7 61 003 10 01 241	Stainless Steel	Yes	-35°C	Yes	1200 l
H7 61 003 10 01 231	Stainless Steel	No	-35°C	Yes	1200 l

*Ex-proof zone 1 and zone 2.

For more information and technical datasheets please contact your BROEN-LAB sales representative.

MOBILE & PORTABLE EMERGENCY SHOWERS

Mobile & Portable Emergency Showers are ideal for areas where a plumbed-in emergency shower is not an option, where water supply or pressure is unavailable, or when permanent installations are undergoing maintenance.

Health & Safety Tower (Unheated)



STANDARD CONFIGURATION

- Emergency eyewash
- Drench hose spray head
- Portable eyewash
- First aid equipment (only for premium)
- Portable first aid box(only for premium)
- Fire blanket (only for premium)
- Fire extinguisher (only for premium)
- Mirror (only for premium)
- Trash bin (only for premium)

TECHNICAL SPECIFICATIONS

- Capacity: 37,5 l
 Min. working temperature: +1°C
 Water flow for eye wash: 2,6 l/min. for 15 minutes
 Water flow for drench hose: 6,4 l/min. for 6 minutes
 Material:
- Stainless Steel cylinder
 - Powder coated aluminum frame

ORDERING INFORMATION

BROEN-LAB item no.	Version	First Aid Equipment	Min. working temperature	Cylinder volume	Clean room ball bearing wheels
2757001	Premium	Yes	+1°C	37,5 l	No
2757002	Premium	Yes	+1°C	37,5 l	Yes
2757011	Basic	No	+1°C	37,5 l	No
2757012	Basic	No	+1°C	37,5 l	Yes

Mobile Self-Contained 114 L Frost-Protected Shower and Eyewash

No. H7470021000321



TECHNICAL SPECIFICATIONS

- Capacity: 114 l
 Min. working temperature: 1°C
 (-10C, but water reaches freezing point after 12hrs)
 Flow rate, body shower: 50 l/min.
 Flow rate, eye wash: 12 l/min.

MOBILE & PORTABLE EMERGENCY SHOWERS

Mobile & Portable Emergency Showers are ideal for areas where a plumbed-in emergency shower is not an option, where water supply or pressure is unavailable, or when permanent installations are undergoing maintenance.

Portable Eyewash/Drench Hose Unit

No. G7370010000203



Other Models

No. G7370020000203
Same, but with dolly

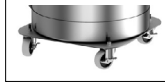

TECHNICAL SPECIFICATIONS

Materials: Stainless Steel
Capacity: 56 l
Min. working temperature: +1°C
Water flow, eye wash: 2,6 l/min. for 15 minutes
Water flow, drench hose: 6,4 l/min. for 6 minutes

Portable Eyewash/Drench Hose Unit, Frost-Protected

No. G7370030000203



Other Models

No. G7370040000203
Same, but with dolly



TECHNICAL SPECIFICATIONS

Materials: Stainless Steel
Capacity: 56 l
Water flow, eye wash: 2,6 l/min. for 15 minutes
Water flow, drench hose: 6,4 l/min. for 6 minutes

Gravity-Flow Portable Eyewash

No. G7330010000402



Furnished with zinc plated steel bracket for mounting unit on wall. Unit can also be placed on countertop or other flat surface.

TECHNICAL SPECIFICATIONS

Materials: Plastic
Capacity: 60,5 l
Weight: 5,9 kg (empty), 71 kg (filled)
Min. working temperature: +1°C
Water flow: 1,9 l/min. for 15 minutes

Bacteriostatic Additive (Accessorie)

No. G7530010000400

Bottle of bacteriostatic additive (236 ml) to protect against growth of bacteria and other impurities in portable unit.



Comes in a case of 4. One bottle will preserve up to 75 litres of potable water for up to six months.

ACCESSORIES FOR FROST PROTECTED SHOWERS

Frost Protected Underground Extension Pipe for Frost Protected Body Showers



-35°C

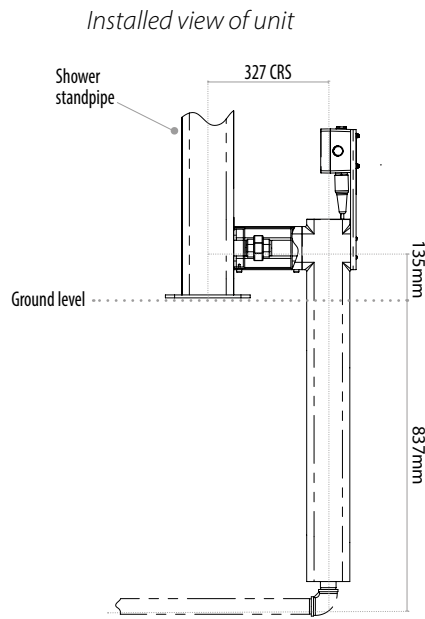

Heated underground extension pipe, trace tape heated and pre-insulated. To be used for connecting to an underground supply.

TECHNICAL SPECIFICATIONS

Min. working temperature: -35°C
 Supply voltage: 230VAC, 50/60Hz
 Power consumption: 21W

ORDERING INFORMATION

BROEN-LAB item no.	Material	 Ex-proof*	Min. working temperature	Mounting
H7 51 001 10 00 221	Stainless Steel	Yes	-35°C	Underground

*Ex-proof zone 1 and zone 2.

Foot Panel for Operation of Body shower

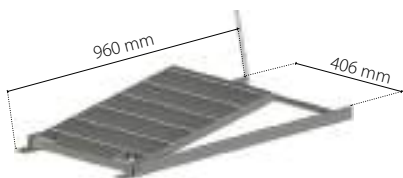

Weight: Approx. 23 kg

No. 17 919 009 - Stainless Steel version

It is possible to combine with 17 909 909 if mounted 180° opposite. (see page 14)

Foot Treadle for Operation of Heated Eye Wash



Ill: No. 17 804 009

No. 17 804 009 - Stainless Steel version

For heated eye washes operational down to -20°C

No. 17 805 009 - Stainless Steel version

For heated eye washes operational down to -35°C

For more information and technical datasheets please contact your BROEN-LAB sales representative.

Emergency Showers Are Important

Thousands of industrial accidents happen every year in spite of precautionary safety measures, accidents that are caused by human exposure to heat (fire, boiling water and oil, steam, etc.), to corrosive agents (fluid acids and caustics) and/or to influence by dust and corrosive aerosols (metal, dirt, fluids).

These accidents may cause the injured person acute pain, disablement and loss of life.

However, experience shows that the consequences and human suffering following such accidents can be considerably limited if water is applied directly to the affected areas instantly after the exposure.

It is a harsh reality that risk lurks in many places: in the laboratory, in the kitchen, in the warehouse, in the chemical plant, in the workshop or generally speaking in any place where heat, corrosion or dust can cause serious human injury.

For these reasons we strongly recommend installation of an adequate emergency shower system as a means of limiting these risks.

Location and Operation of Emergency Showers

The shower must be located as close to the workplace as possible so that the general first aid instructions of flushing the affected area immediately after the accident has occurred can be followed.

Please note that if strong acids or caustics are involved immediate action is required.

When installing the emergency shower system please also be aware that it must be easy to locate and access at all times for potential users.

The BROEN-LAB showers can be recognized by their red body shower pull rods and red eye shower push handles. In addition the inter-nationally adapted graphic symbols for the clear identification of emergency shower installations are always included in BROEN-LAB solutions.

Further information and guidelines can be found in the EN 15154 part 1 & 2 - European standard for Emergency safety showers

Operation

All BROEN-LAB emergency shower systems are designed and engineered to be easily operable. This allows for "one-action" activation of the shower ensuring immediate and continued flushing without any need for further action.

The easy operation also allows the injured person to use both hands to keep the eyes open for effective flushing, to undress under the shower, or just to help exposing the affected area for better and more expedient treatment.

On the eye shower, the nozzles are protected by rubber cups to keep the injured person from hurting themselves unintentionally. The nozzles are also protected against dust and dirt by the caps which are removed automatically by the initial jet of water.

Water Pressure and Temperature

Emergency showers shall be connected to a cold water system with at least drinking water quality which ensures clean and fresh water. In addition, we recommend the water temperature to be kept within the range of 15° to 25° Celsius in order to provide the best immediate effect, reasonable human comfort, and at the same time avoid hypothermia.

All eye showers are delivered with FLOWFIX water regulating devices ensuring constant adequate water flow regardless of high water pressure.

The illustrations will inform you of the capacities of the showers.

Threading

In general the BROEN-LAB Emergency Showers are equipped with threadings as follows:

E.g. G 1/2": In accordance to ISO 228/1.

E.g. NPT 1/2": In accordance to ANSI-B1.20.1.

Maintenance and Information

When installing emergency shower systems, the relevant safety advisor must provide instructions on operation and maintenance.







As basic information the potential user must be advised of:

- The location of the emergency shower system
- How to operate it and
- How to behave in case of an emergency

BROEN-LAB recommends users to check installed emergency shower systems once a week.

IN CASE OF AN EMERGENCY

In the event of accidents caused by human exposure to heat, corrosive agents, and/or to influence of dust and corrosive aerosols:

-  Start flushing immediately – the seconds count.
-  Remove contaminated clothing which is not stuck to the skin.
-  Continue flushing.
-  In case of an eye injury keep the eyelid open when continuing flushing.
-  Call for an ambulance. Ask the doctor for advice.
-  Continue flushing in the ambulance.
-  Keep the flushing in the emergency room and during transport to the special ward.

In case of blistering, inform the doctor and the hospital about the substance in question and about possible countermeasures.

RAPID ACTION CAN BE OF VITAL IMPORTANCE.

PERSONAL WASH UNIT

The first seconds following an eye injury are often critical to keeping injury to a minimum. A personal wash unit may be kept in the immediate vicinity of employees working in a potentially hazardous area.

The main purpose of these units is to supply immediate flushing. With this accomplished, the injured individual should then proceed to a plumbed or self-contained eyewash and flush the eyes for the required 15-minute period.

REFERENCE: A1 PERSONAL WASH UNIT, ANSI Z358.1.

INTERNATIONAL STANDARDS
NORM EN 15154-1&2
 (European Committee for Standardization)

MAIN REQUIREMENTS

- The water supplied by the body shower shall be of constant flow rate in accordance with national regulations at a flow pressure to be specified by the manufacturer. The flow pressure shall be specified and measured where the shower is connected to the water system. The body shower shall be capable of delivering this supply for a minimum of 15 minutes. Note: When no national or local regulations apply, a constant flow rate of min. 60 l/min is suitable.
- It shall only be possible to make adjustments with a tool to the direction of spray or the water distribution of a shower head. The shower head shall be self-draining between the valve and the outlet. The shower head shall be removable for maintenance but only by use of a tool.
- At a distance 700 mm below the shower head, 50% (+/-10%) of the volume of water delivered shall fall in a circle with a radius of 200mm; the water level in the individual compartments in this circle shall not deviate by more than 30% from the mean value. At this measuring level, the area reached by minimum 95% of the water shall be limited to a circle with a radius of 400 mm. The velocity of the water spray shall be low enough to be non-injurious to the user.
- The shower head shall be designed to be installed so that its lower edge is (2200 +/- 100) mm above the level on which the user stands.
- The valve shall not close automatically once it has been opened. The direction of operating the valve actuator shall be clearly visible and unmistakable.

Flow rate: Min. 60 l/min

OPEN SPACE

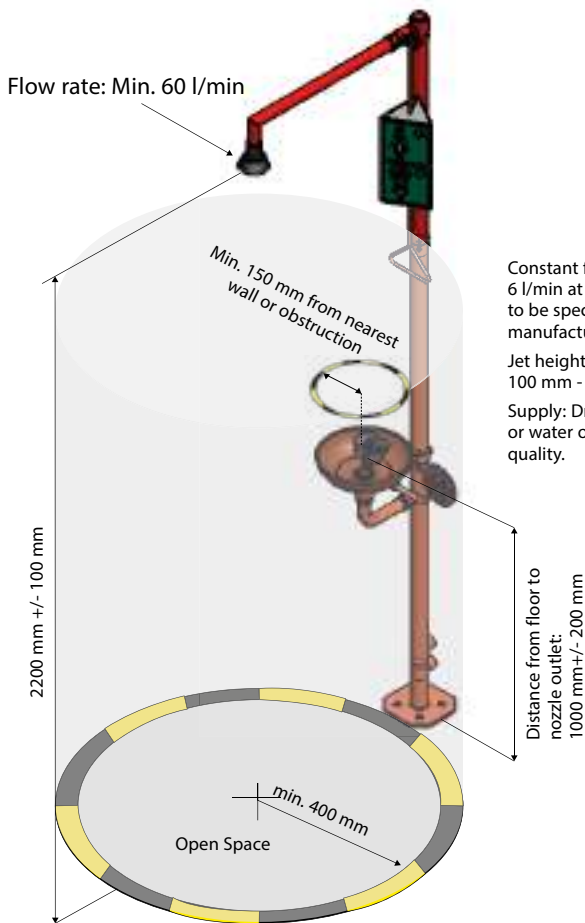

Constant flow rate of min 6 l/min at a flow pressure to be specified by the manufacturer.

Jet height of water: 100 mm - 300 mm

Supply: Drinking water or water of equivalent quality.

WATER PATTERN

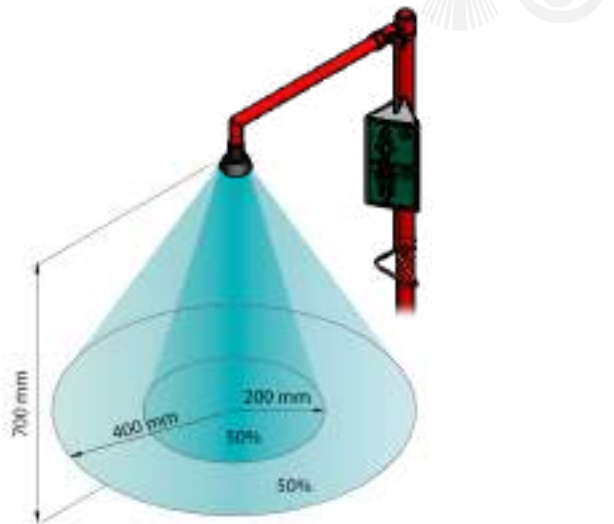

TYPE TESTING OF WATER DISTRIBUTION

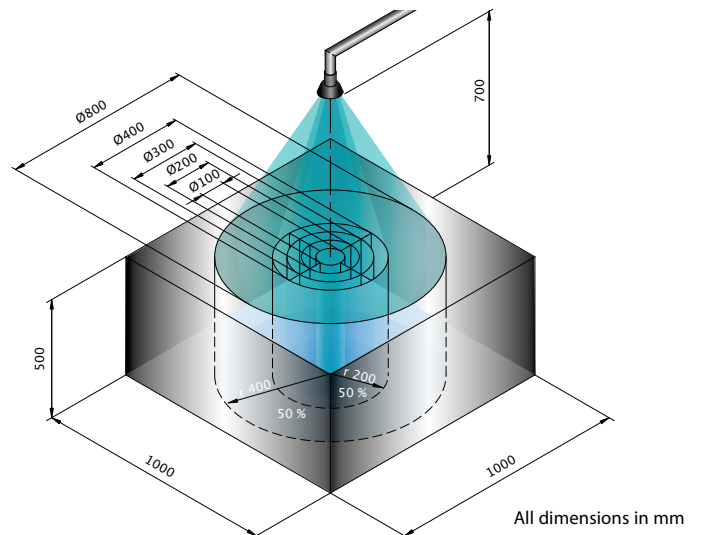

Please refer to www.BROEN-LAB.com for a 3rd party certificate for EN 15154

INTERNATIONAL STANDARDS

NORM ANSI Z 358.1

(American National Standard Institute)

MAIN REQUIREMENTS

- Emergency eyewash and showers must be located in such a way that they can be reached by the user within maximum 10 seconds and available for immediate use (ref.: 4.5.2 + Safety considerations - B5).
- Eye/face showers must be able to deliver at least 11.4 l. water per minute continuously for at least 15 minutes (ref.: 6.1.6).
- The handle of pull rod must be located at a maximum height of 173.3 cm above the floor (ref.: 4.2).
- The valve must go from "off" to "on" position within 1 second or less and be able to remain open without further action. (ref.: 4.2).
- The body shower must be capable of delivering flushing fluid at a minimum of 75.7 liters per minute continuously for a minimum of 15 minutes (ref.: 4.1.4).

- The diameter of the water spray pattern must be minimum 50.8 cm measured at 152.4 cm above the floor (ref.: 4.1.4).
- The face of the showerhead shall be located within a range of 208.3 cm to 243.8 cm from the floor (ref.: 4.4.1).
- The eye/face showers flushing fluid flow pattern must be located within a range of 83.8 cm to 134.6 cm above the floor (ref.: 5.4.4).
- The shower must be activated at least once a week (ref.: 4.6.2).
- Tepid water is required in all showers (ref.: 4.5.6 + Safety considerations - B5).

Reference: ANSI Z 358.1-2014

OPEN SPACE

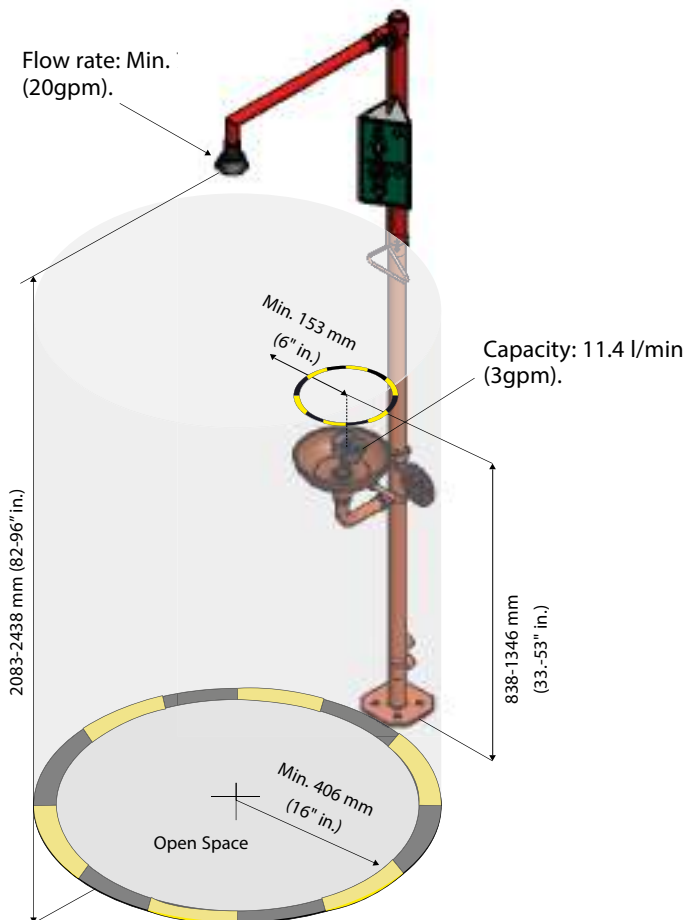

WATER PATTERN

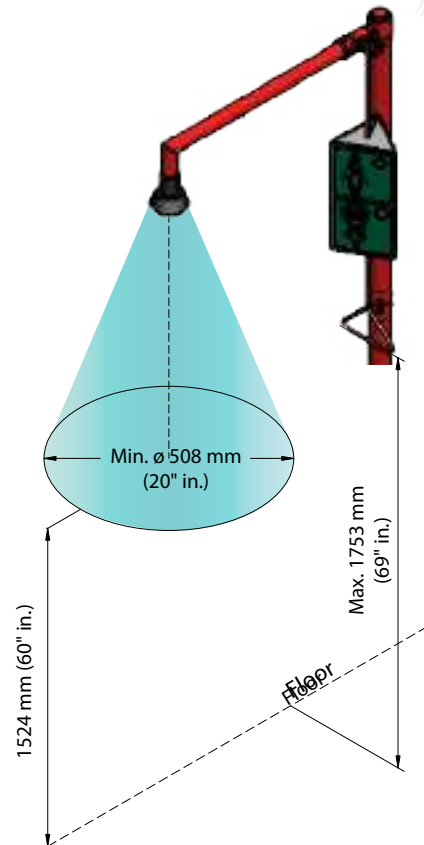

EMERGENCY SHOWER SYSTEMS

An eye shower is the only allowable exception from the rule that no obstructions are allowed in the "open space".

Please refer to www.BROEN-LAB.com for a 3rd party certificate for ANSI Z358.1.

SPECIFICATION OF MATERIALS

Shower outlet	Brass/PP or PPO
Stand pipe	Stainless steel (AISI 304) or brass
Rubber cups	EPDM
Dust caps	POM
Bowl	Stainless steel (AISI 304)

Available in chemical resistant "BROEN-LAB Polycoat" (polyester powder coating) or "Stanniloy" plating (a highly anti-corrosive treatment based on a tin/nickel alloy).

SPECIFICATION OF MATERIALS FOR STAINLESS STEEL RANGE

Shower outlet	SS 316/PP or PPO
Stand pipe	Stainless steel (AISI 316)
Rubber cups	EPDM
Dust caps	POM
Bowl	Stainless steel (AISI 316)

TECHNICAL SPECIFICATIONS

Min. working pressure (Dynamic/Flow pressure): See individual products.

Recommended max. working pressure:

kPa	kN/m ²	bar	psi
500	500	5	72.5

Max. working pressure (Static):

kPa	kN/m ²	bar	psi
1000	1000	10	145

Recommended temperature: 25°C.
Alternatively, install TMV.

FLOWFIX



FLOWFIX is a feature that is built into most of BROEN-LAB's eye baths and hand/eye showers. Flowfix is a water regulating device, that controls the water flow at a preset rate regardless of water pressure.

SELF-DRAINING SHOWER HEAD

BROEN-LAB has developed a new self-draining emergency shower head in compliance with both EN15154-1 and ANSI Z358.1.

BROEN-LAB has 3rd party certificate for EN 15154 and ANSI Z358.1-2014. The self-draining shower head requires min. 1 bar (14.5 psi) and max. 10 bar (145 psi) dynamic water pressure for optimal function.

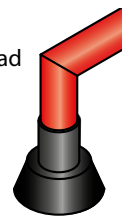

FEATURES & BENEFITS

- ✓ Self-draining, anti lime scale - prevents bacteria build-up and reduces maintenance
- ✓ Complies to both EN & ANSI Standards
- ✓ Chemical resistant PPO plastics / SS 316
- ✓ Soft water spread
- ✓ Available for 1/2", 3/4" and 1" pipes



CALCULATING THE FLOWRATE AND DYNAMIC PRESSURE DROP

Any calculation can be done using the following formulas:

$$K_v = \frac{q_v [\text{m}^3/\text{h}]}{\sqrt{\Delta P [\text{bar}]}} \quad \text{or} \quad q_v = K_v \times \sqrt{\Delta P} \quad \text{or} \quad \Delta P = \left(\frac{q_v}{K_v}\right)^2$$

Where

K_v = flowrate [m³/h] or [l/sec] at 1 bar pressure drop

q_v = flowrate [m³/h] or [l/sec]

ΔP = pressure drop [bar]

1) Please note that eye showers with built-in FLOWFIX have a fixed flowrate.

Examples:

What pressure drop is needed in order to achieve 75 l/min = 1.25 l/sec through a body shower with 1/2" inlet?

$$\Delta P = \left(\frac{q_v}{K_v}\right)^2 = \left(\frac{1.25 [\text{l/sec}]}{1.08 [\text{l/sec}]}\right)^2 = 1.34 [\text{bar}]$$

What flowrate can be expected through a free standing body shower with top inlet at a pressure drop of 1.5 bar?

$$q_v = K_v \times \sqrt{\Delta P} = 1.10 [\text{l/sec}] \times \sqrt{1.5 [\text{bar}]} = 1.35 [\text{l/sec}] = 80.8 [\text{l/min}].$$

K_v VALUES

Type of shower	Eye shower without FLOWFIX ¹⁾	Body shower 1/2" pipe or inlet	Body shower 3/4" pipe or inlet	Body shower 1" pipe or inlet	Free standing-body shower, top inlet	Free standing-body shower, bottom inlet	Thermostatic mixing valve 27 03 007 1035	Thermostatic mixing valve 17 512 009/17 513 009
K_v-value m ³ /h	0.75	3.89	4.3	5.31	3.97	2.99	1.05	4.7
l/sec	0.21	1.08	1.19	1.48	1.10	0.83	0.29	1.33

SYMBOLS:



Eye shower



Body shower



For disabled people as well

HEADQUARTER

BROEN-LAB A/S

Drejervaenget 2
5610 Assens
Denmark

Tel. +45 6376 6376

lab@broen-lab.com
broen-lab.com

INTERNATIONAL OFFICES

BROEN-LAB Ltd.

Tel. +44 121 522 4515

lab@broen-lab.com
broen-lab.com

BROEN-LAB Singapore Pte. Ltd.

25 International Business Park
#04-60A German Centre
Singapore 609916

Tel. +65 6298 0662

lab@broen-lab.com
broen-lab.com

BROEN-LAB GmbH

Tel. +45 6376 6376

lab@broen-lab.com
broen-lab.com

BROEN-LAB Sverige AB

Tel. +45 6376 6376

lab@broen-lab.com
broen-lab.com

BROEN-LAB Inc.

15 Constitution Drive
Suite 122
NH 03110
Bedford
USA

Tel. +1 603 310 5089

lab@broen-lab.com
broen-lab.com

BROEN-LAB develops, manufactures and sells Laboratory Fittings, Emergency Shower Systems and Eye Wash Systems into a broad spectrum of laboratories and industrial locations; sectors include Pharmaceutical, Food&Beverage and Academia. Our expertise and product quality ensure optimal solutions compliant to all relevant international norms setting new standards in risk mitigation in modern research and development facilities.

BROEN-LAB offers solutions that ensure the functionality, compliance, hygiene, durability and safety are of the highest priority. For more than 50 years our products have been integrated into a wide variety of workplaces, laboratories, hospitals and industrial locations, with features that are assessed and designed to be flexible, durable and compliant offering a broad range of options tailored to each location. This inherent design integrity provides confidence in the solution adopted wherever in the world these are applied.

BROEN-LAB is a collaboration partner in the design and layout of your next laboratory and it's integrated safety.



BROEN-LAB A/S ISO 9001 certification

In September 1991 BROEN-LAB A/S was certified according to ISO 9001 as one of the first Danish companies. The certification was carried out by Bureau Veritas, Denmark, for our Danish site in Assens.

The quality management system of BROEN-LAB A/S now complies with detailed specifications laid down by the internationally acknowledged EN ISO 9001:2015. This certification will further contribute to reputation for quality and reliability of BROEN-LAB A/S.

BROEN-LAB A/S ISO 14001:2015 certification

In December 2022 we got certified according to ISO 14001 in Environmental certification. The new certification was carried out by Bureau Veritas, Denmark, for Danish site in Assens. The Environment ISO14001 management system of BROEN-LAB A/S is included in internationally acknowledged EN ISO 9001:2015. Both certifications furthermore contribute to reputation for quality and reliability of BROEN-LAB A/S.